

Dimensional Specifications: in. [mm]

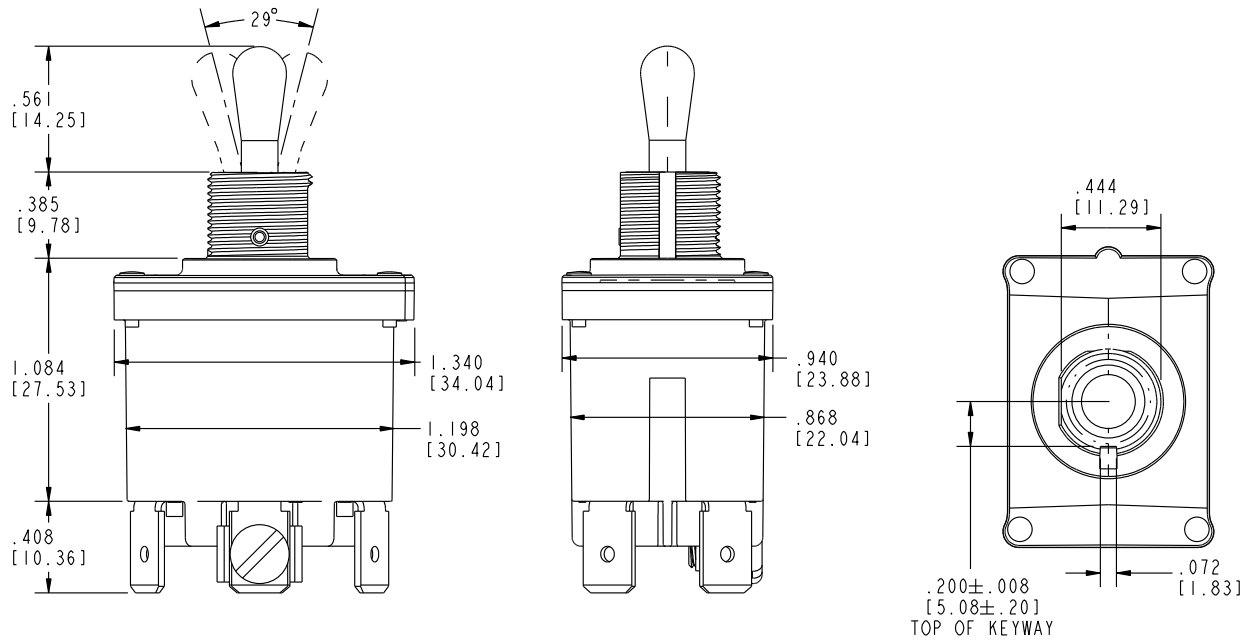

TERMINALS

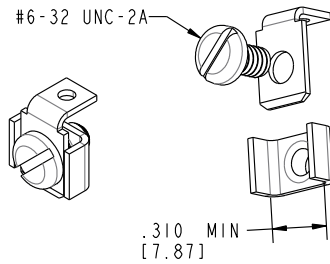

SCREW (AND CAGE) TERMINAL

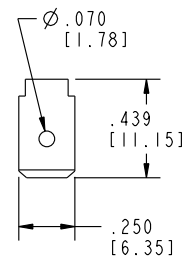
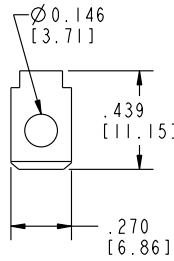

.250 TAB (O.C.) TERMINAL

PANEL CUTOUTS

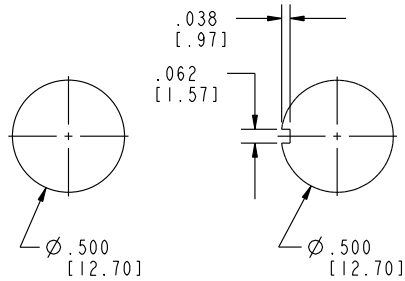

MOUNTING HOLE

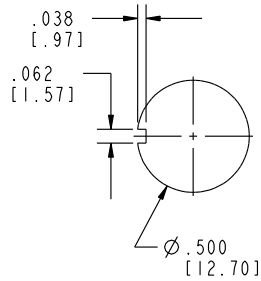

WITH KEYWAY

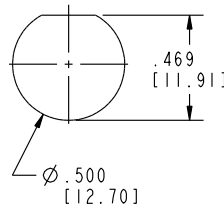

WITH FLAT

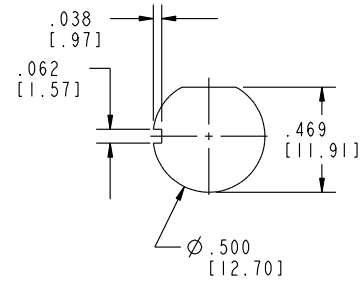

WITH KEYWAY, FLAT