

Technical Bulletin 016 – Zero 36₂0 Installation Guide

Rev3 06/12/2016

The Lifeline Zero 36₂0 extinguisher (UK Patent No. GB 2523902./UK Patent Application No. 1516832.1.) is homologated to FIA8865-2015 standard and is the latest and most advanced motorsport fire extinguisher system available. This system provides the greatest level of protection for you and your vehicle and has been extensively tested by Lifeline, the FIA, BSI and UK MOD, to not only meet the FIA 8865-2015 requirements, but to surpass it. The information below provides a guide to installing your chosen system. Unfortunately, due to the variety of vehicles being raced the exact location of the components of the systems cannot be fully defined by Lifeline; this document provides “best practise” advice suitable for the vast majority of vehicles. If you feel that your installation cannot follow these guidelines please contact Lifeline Technical for further guidance.

Fully read and understand the instructions below before starting installation. Plan your installation carefully referring to the tables below and the system drawings. Do not cut the supplied tubing, over-braid or the plug and lead sets until you are certain of the location of the cylinder, connectors, nozzles, switches and power pack.

Other References	
TB001	System Care, maintenance and Service
TB003	Novex MSDS
TB005	AFFF MSDS
TB017	Zero 36 ₂ 0 – Kit Content and Spares

Section 1 – Cylinder, Bracket and Straps

Item	Fixing Type and No.	Location and Fitting Guide
Cylinder and Bracket - Cockpit	4xM6 nut, bolt and washers. Vibration washers and/or Nylocs are highly recommended. The use of self-tapping screws or inserts is not permitted	<p>Mount transversally towards the middle/rear of the car for direct discharge, and within the safety cell/roll cage. Orientation is free for remote discharge, and within the safety cell/roll cage. For recommended location, refer to Section 6.</p> <p>Serial label must be visible for scrutineering. Avoid positions where cylinder is likely to be damaged or be exposed to excessive heat.</p>

Item	Fixing Type and No.	Location and Fitting Guide
Cylinder and Bracket – Engine Bay	4xM6 nut, bolt and washers. Vibration washers and/or Nylocs are highly recommended. The use of self-tapping screws or inserts is not permitted	Mount transversally or longitudinally in the cockpit close to the engine compartment bulkhead within the roll cage or safety cell. For recommended location, refer to Section 6. Serial label must be visible for scrutineering. Avoid positions where cylinder is likely to be damaged or be exposed to excessive heat.
Straps	2No. T-Bolt straps/cylinder	Thread through provided slots in brackets and around the cylinder. Tighten T-bolts using spanner.

Section 2 – Delivery Network – Tube and Connectors

Item and System Type	Fixing Type and No.	Location and Fitting Guide
-10 Hose – Cockpit (where supplied)	Supplied bracket, cable ties or P'clips as required	Where the remote nozzle option is used, connect the -10 hose to the cylinder tightening to 60Nm and locate the other end of the hose at the remote nozzle position (see section 3 & 6). Secure the hose using cable ties or P'clips. <i>Lifeline recommend torque marking the hose connections to provide a simple visual check that it is secured at the cylinder and nozzle</i>
-6 Hose – Engine Bay	Cable ties or P'clips as required	Either, drill a Ø23mm hole to allow the hose to pass through the fire wall into the engine bay and mount the nozzle on a separate fabricated bracket as close to the top of the engine bay as possible OR drill a Ø23mm hole to bulkhead mount the nozzle as close to the top of the engine bay as possible. Tighten the -6 hose to 30Nm <i>Lifeline recommend torque marking the hose connections to provide a simple visual check that it is secured at the cylinder and nozzle</i>

Item and System Type	Fixing Type and No.	Location and Fitting Guide
8mm Tube – Engine Bay	Cable ties or P’clips as required	Hand form 8mm tube as required to allow connection to cylinder and Bar Nozzles, minimum bend radius 25mm (50mm recommended). Cut the tube using a pipe cutter only, DO NOT USE A HACKSAW, ensuring the end of the pipe remains round and is not misshapen by the cutting process. Secure using cable ties or P’clips.
8mm Tube Connectors	Cable ties for equal-T	Drill a Ø13.6mm hole for the bulkhead fitting and secure through the hole. Secure equal-T using cable ties. Insert the ends of the 8mm tube or bar nozzles fully into each connector, ensuring the olive is in place, and tighten to 38Nm.

Section 3 – Nozzles

The cockpit nozzle (direct fit to cylinder or remote fit) discharges suppressant to the roof of the car forming a gaseous blanket which rapidly extinguishes a fire. The high discharge (HD) engine bay nozzle flood fills the compartment with a gaseous suppressant for fast “knock-down” of fire and the bar nozzles keep the fire from reigniting due to hot engine components. Consideration should be given to location of the bar nozzles for best coverage of the engine from both sides

Nozzle Type	Fixing Type and No.	Location
Cockpit – Direct fit or Remote Fit Nozzle	None required for direct fit, supplied bracket and P’clips for remote fit	The nozzle (direct fit or remote fit) must be aimed towards the centre of the roof of the car ensuring even dispersal of suppressant to the entire cockpit. The nozzle must not be obstructed in any way and must have clear line of sight to the roof of the car. Obstruction could reduce the effectiveness of the extinguisher. DO NOT AIM THE NOZZLE DIRECTLY AT OCCUPANTS
Engine – HD Nozzle	Bulkhead mount or fabricated bracket	Locate the HD nozzle as high as possible at the rear of the engine bay, aimed at the engine and as close to the centre line of the car as possible. The axis of the nozzle should be horizontal.
Engine – Bar Nozzles	P’clips as required	Locate the Bar Nozzles either side of the engine, either front and back of the engine bay for a transverse engine or either side for a longitudinal engine. The axis of the nozzles should be horizontal and the holes aimed at the engine

Section 4 – Activation

Item	Fixing Type and No.	Location
Power Pack	4No. M4 Countersunk screw and nuts	<p>The power pack must be located where it can be reached and operated by the driver/co-pilot. In the majority of cars this will be on the centre of the dash or centre console area.</p> <p>Ensure that the LED indicator lights are visible to the driver and that cables are routed so that they cannot be accidentally damaged.</p>
Activation Switches	Ø13.6mm hole and supplied lock nut	<p>Locate one switch in the cockpit where it can be reached by the driver.</p> <p>Locate the second switch externally directly next to the electrical cut-off switch</p>
Plug and Leads	Cable ties as required	<p>Plug and lead sets have colour coded heat shrink at the plug end to identify which connection on the extinguishers and power pack they go to.</p> <p>Locate each plug and lead as required between Power Pack, Activation Switches and Extinguishers. Solder joints, sealing with glue lined heat shrink to protect from water ingress. Pay particular attention to the joints at switches and cover the pins with glue lined heat shrink to prevent moisture ingress and prevent accidental short circuits.</p> <p>Refer to system schematic in Section 6.</p>
Remote Activation	Cable ties as required	<p>If the remote activation option has been added to your power pack, you will have the ability to activate the extinguisher system via the cars telemetry links from the pits. Follow the instruction above for Plug and Leads.</p> <p>This cable is colour coded YELLOW and requires a 5-20V input for 0.3sec</p>

Section 5 – System Checking

Item	Procedure
Power Pack	<ol style="list-style-type: none"> 1. Fit the supplied PP3 battery to the power pack (<i>Lifeline recommend removing the battery from the power pack in between races</i>) 2. Connect all plug and leads once they have been fully assembled following the instruction in Section 4. and diagram in Section 6. 3. Ensure the two position toggle switch on the power pack is in the TEST position 4. Press one of the two activation switches. The power pack then performs automatic checks of the battery condition and wiring loom 5. If the system is correctly wired and the battery condition is good, the AMBER LED will illuminate for ~5 seconds and then go out. (<i>Remote activation option can also be checked by pressing the activation button in the pits and having the driver confirm that the TEST LED illuminates and goes out as above</i>) 6. If the AMBER LED flashes there is a problem. 7. Error codes are: - <ol style="list-style-type: none"> a. 2 flashes = Battery problem – replace battery b. 3 flashes = Circuit problem – check BLUE plug and lead sets and activation switches c. 4 flashes = Circuit problem – check GREEN plug and lead set and activation switches 8. Once the system has confirmed that it is working correctly (no error codes), move the switch to the ARMED position. The RED LED will now flash every 3 seconds 9. The system continuously monitors the battery and circuit, if an error is found the RED LED will cease to flash
Cockpit Extinguisher	<ol style="list-style-type: none"> 1. Check that the cylinder is in date and has been serviced every two years as required 2. Check the weight of the extinguisher against that shown on the serial label. Lifeline use regularly calibrated highly accurate scales and it can be expected that some variance will be found from the weight as shown when using other equipment 3. Check to see that the indicator pin is proud of the rear face of the extinguisher. It can be expected that this pin will retract in cold temperatures due to contraction of the suppressant in the extinguisher. This is normal, if in doubt, weigh the cylinder as above
Engine Extinguisher	<ol style="list-style-type: none"> 1. Check that the cylinder is in date and has been serviced every two years as required 2. Check the weight of the extinguisher against that shown on the serial label. Lifeline use regularly calibrated highly accurate scales and it can be expected that some variance will be found from the weight as shown when using other equipment

Section 6 – System Illustrations

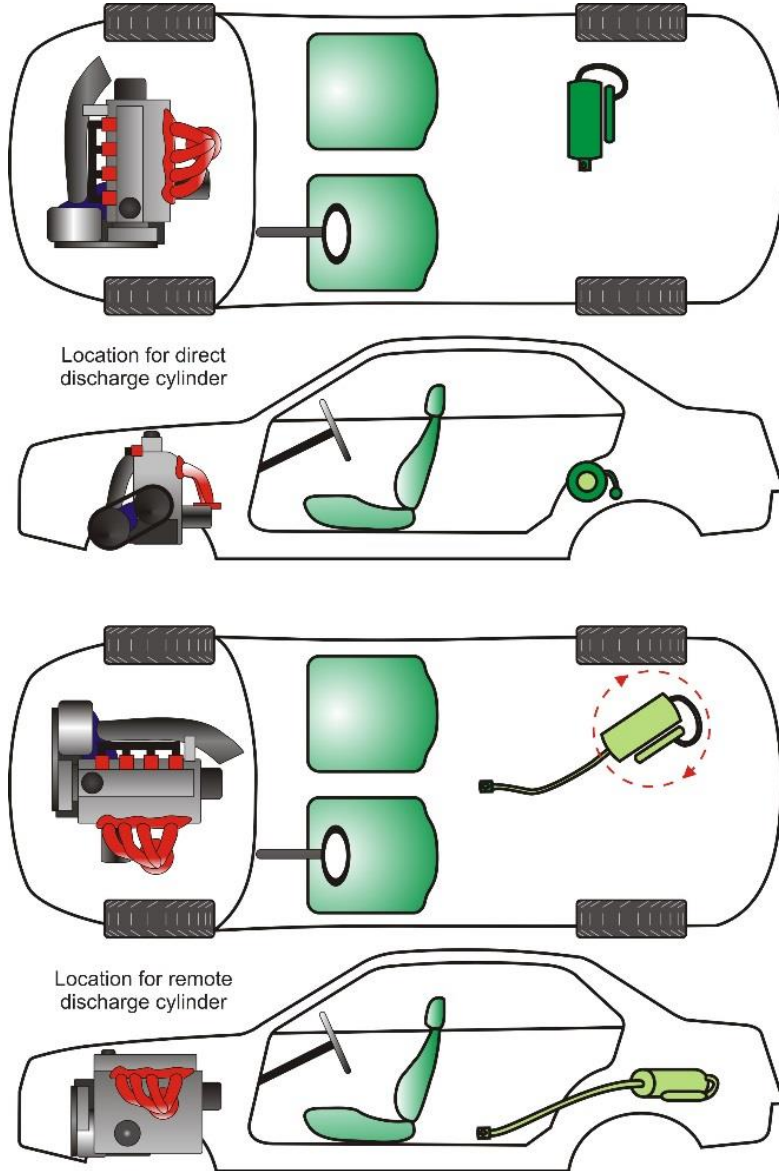

Figure 1 – Cockpit Cylinder Locations

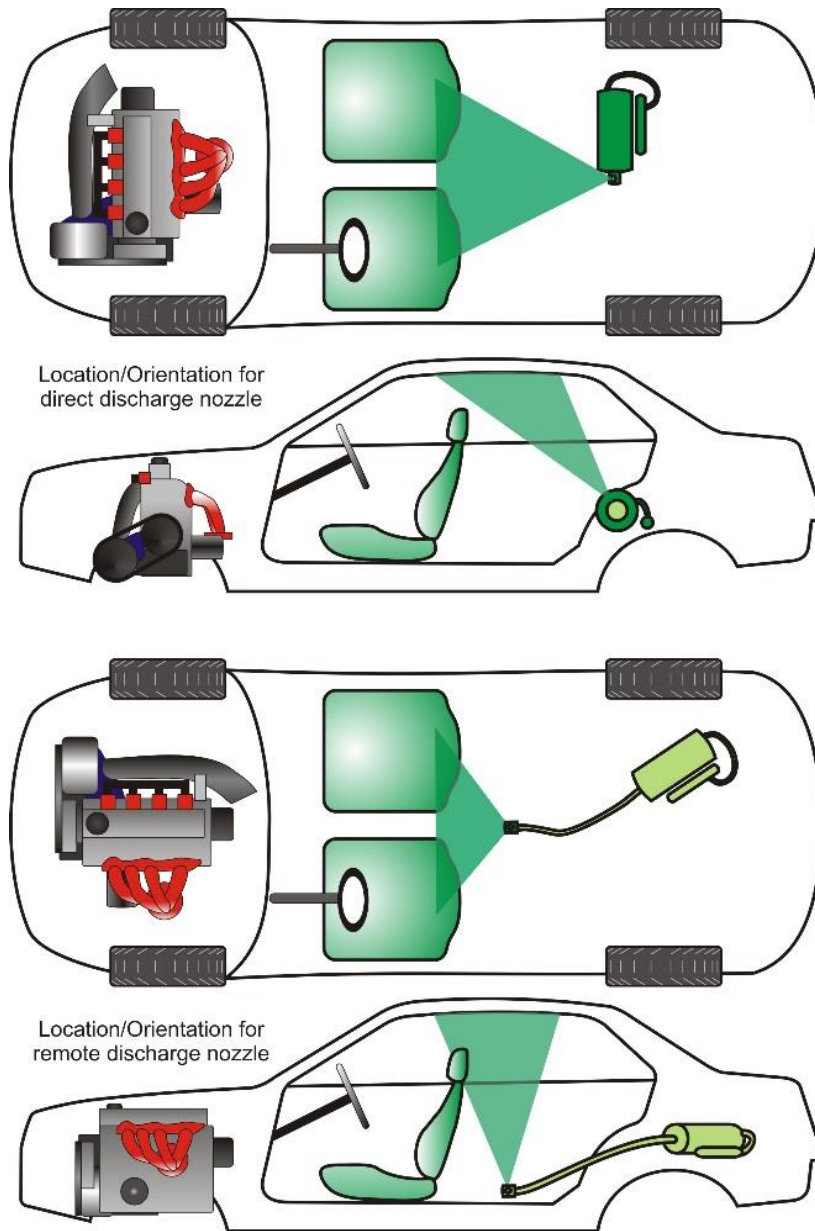

Figure 2 - Cockpit Nozzle Location/Orientation

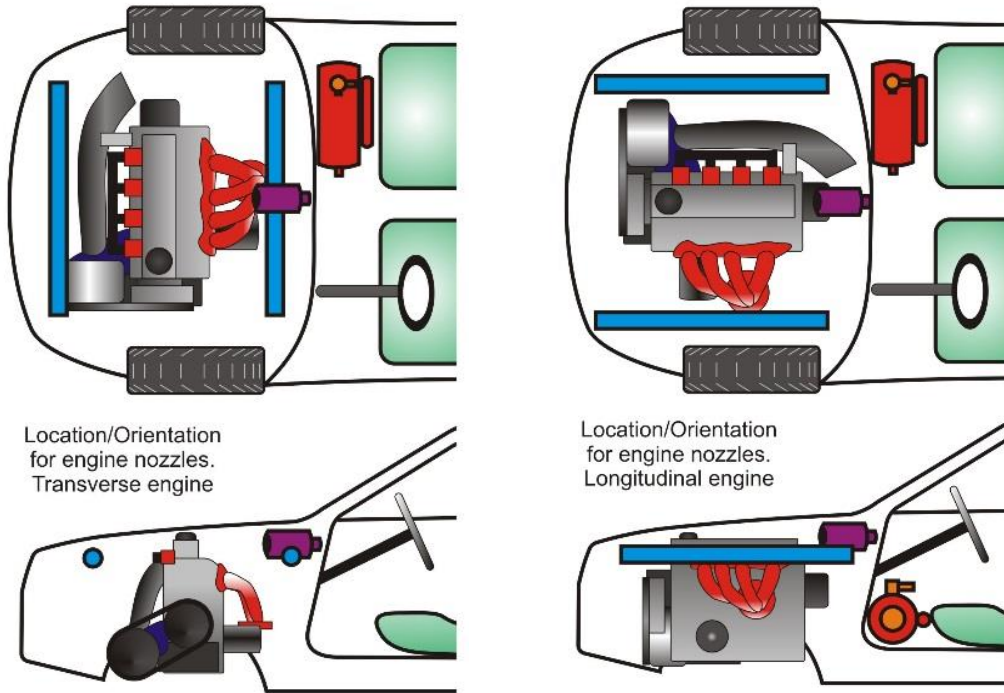

Figure 3 – Engine Cylinder and Nozzle Locations

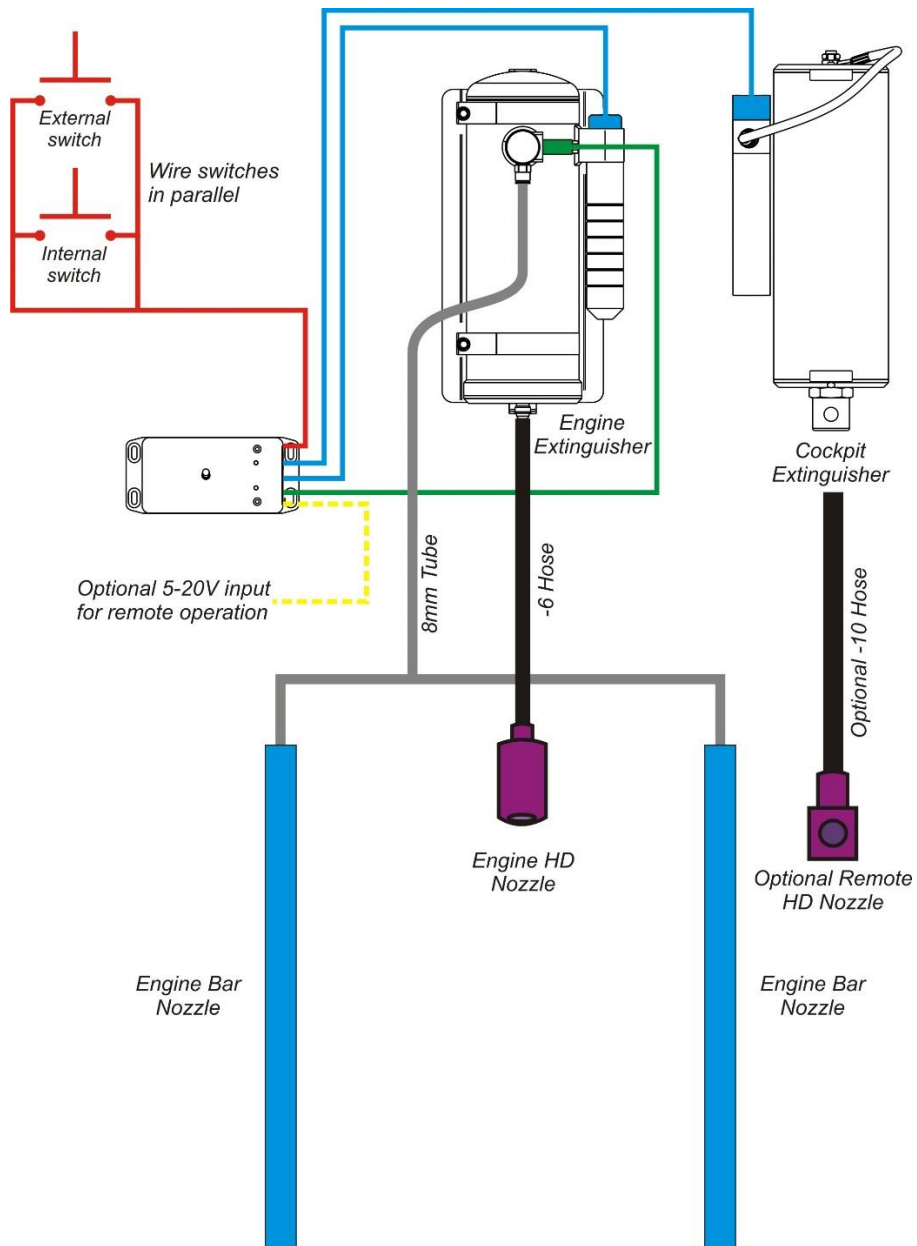

Figure 4 - System Schematic

System Part Number	
System Serial Numbers	
Date of Manufacture	
Service 1 Date	
Service 2 Date	
Service 3 Date	
Service 4 Date	
Service 5 Date	
Notes	



1. INSTALLATION DU SYSTEME D'EXTINCTION / FIRE EXTINGUISHER SYSTEM INSTALLATION

101. INSTALLATION DANS L'HABITACLE / COCKPIT INSTALLATION

- a) Emplacement et orientation du corps
Location and orientation of body
- b) Emplacement et orientation des buses
Location and orientation of nozzles
- c) Précaution à prendre lors de l'installation du système
Special care to take with the installation of the system

Transversally, towards the middle/rear of the car for direct discharge, and within the safety cell/roll cage. Orientation is free for remote discharge, and within the safety cell/roll cage.

Aimed towards the centre of the roof of the car and having direct line of site to the roof of the car with no obstructions. Nozzle can be either directly mounted to the cylinder or on the end of a JIC -10 hose

Nozzle must not be obstructed in any way. Do not aim the nozzle at occupants of the car. Ensure cylinder is not positioned where it could be damaged or exposed to extreme heat See Lifeline Technical Bulletin 016 for detailed installation instructions

E1-1) Installation dans l'habitacle (emplacement et orientation du corps)

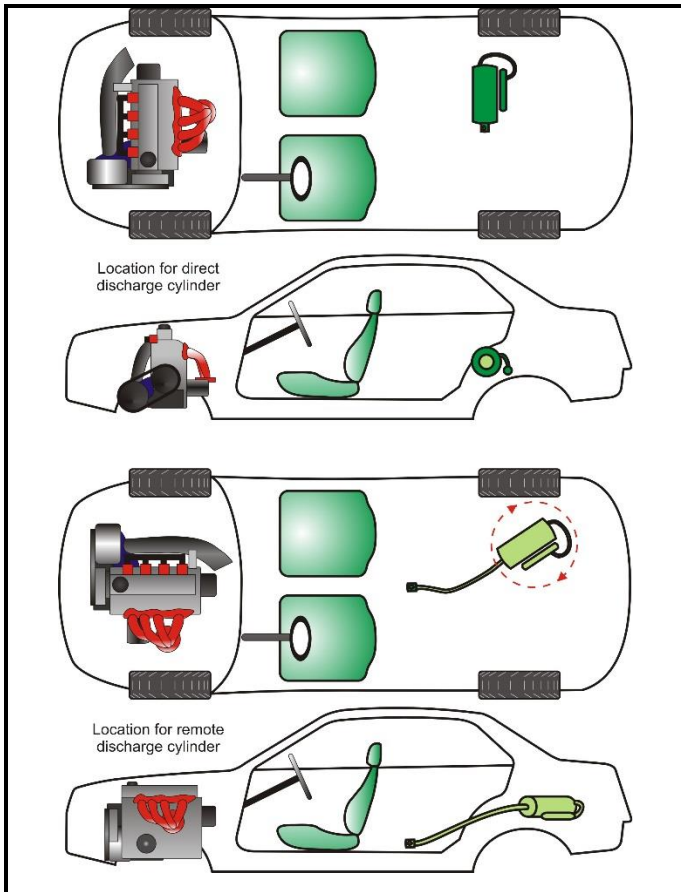

E1-2) Installation dans l'habitacle (emplacement et orientation des buses)

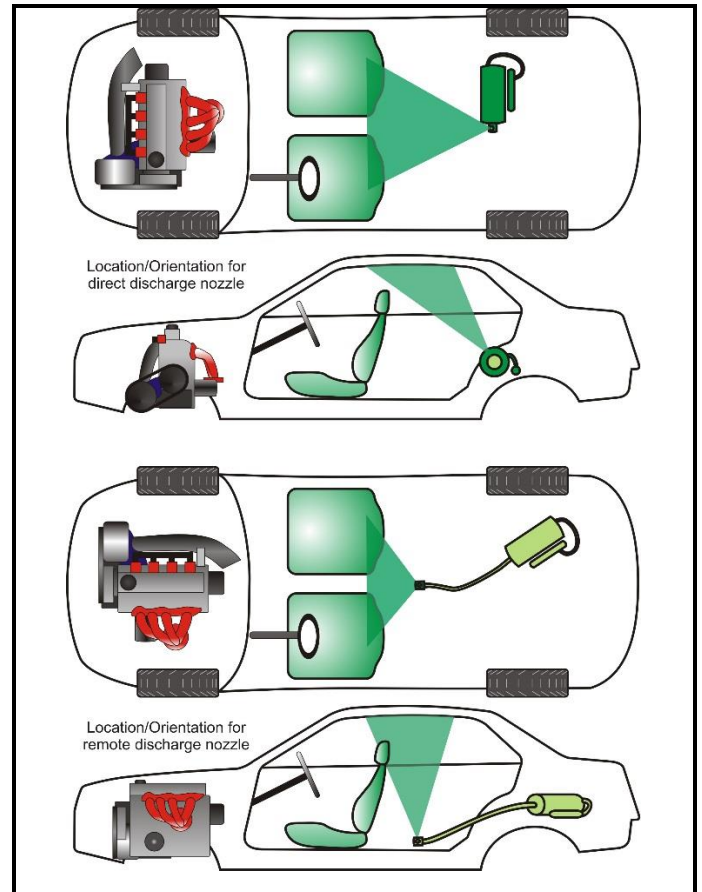



102. INSTALLATION DANS LE MOTEUR / ENGINE INSTALLATION

- a) Emplacement et orientation du corps
Location and orientation of body
- b) Emplacement et orientation des buses
Location and orientation of nozzles
- c) Précaution à prendre lors de l'installation du système
Special care to take with the installation of the system

Transversally or longitudinally in the cockpit close to the engine compartment bulkhead

High discharge nozzle mounted towards the rear of the engine compartment aimed at the engine, close to the bulkhead on a fabricated bracket or mounted on/through the bulkhead and as high as possible, axis being horizontal and holes aimed at the engine. Bar nozzles mounted either side of the engine (front and rear of engine bay for transverse engine, either side for longitudinal engine), axis being horizontal.

See Lifeline Technical Bulletin 016 for detailed installation instructions

E2-1 Installation dans le moteur (emplacement et orientation du corps)

Engine installation (location and orientation of body)

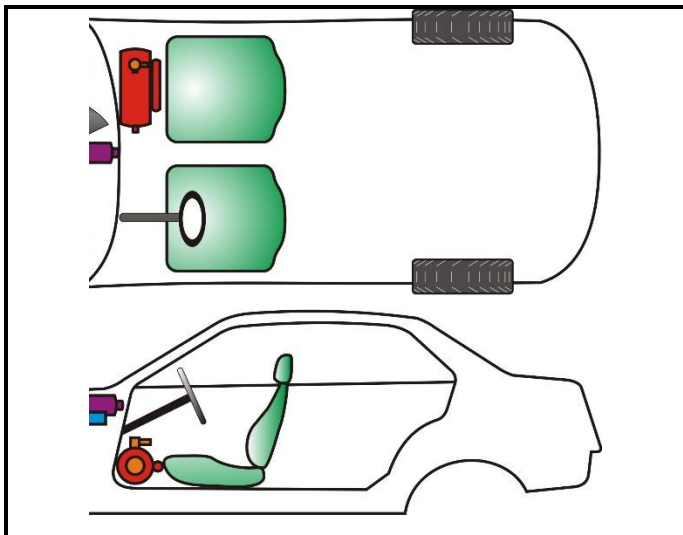

E2-2 Installation dans le moteur (emplacement et orientation des buses)

Engine installation (location and orientation of nozzles)

